

## Warranty, Service & Repair

To register your product with the manufacturer, go to the Flowline website for on-line registration. The website address is as follows:

*www.flowline.com.*

On-line Warranty Registration can be found under Contact Us in the Navigation Bar along the side of the home page.

If for some reason your product must be returned for factory service, contact Flowline Inc. at (562)598-3015 to receive a Material Return Authorization number (MRA), providing the following information:

1. Part Number, Serial Number
2. Name and telephone number of someone who can answer technical questions related to the product and its application.
3. Return Shipping Address
4. Brief Description of the Symptom
5. Brief Description of the Application

Once you have received a Material Return Authorization number, ship the product prepaid in its original packing to:

Flowline Factory Service  
MRA \_\_\_\_\_  
10500 Humbolt Street  
Los Alamitos, CA 90720

To avoid delays in processing your repair, write the MRA on the shipping label. Please include the information about the malfunction with your product. This information enables our service technicians to process your repair order as quickly as possible.

# FLOWLINE®

## Non-Intrusive RF Capacitance Level Switch LP50 Series Owner's Manual



CE



Version 6.0A

© 2002 FLOWLINE Inc.

All rights reserved.

Manual # LP900002 - LP50-0510-M6\_0A

## WARRANTY

Flowline warrants to the original purchaser of its products that such products will be free from defects in material and workmanship under normal use and service for a period which is equal to the shorter of one year from the date of purchase of such products or two years from the date of manufacture of such products.

This warranty covers only those components of the products which are non-moving and not subject to normal wear. Moreover, products which are modified or altered, and electrical cables which are cut to length during installation are not covered by this warranty.

FLOWLINE's obligation under this warranty is solely and exclusively limited to the repair or replacement, at FLOWLINE's option, of the products (or components thereof) which FLOWLINE's examination proves to its satisfaction to be defective. FLOWLINE SHALL HAVE NO OBLIGATION FOR CONSEQUENTIAL DAMAGES TO PERSONAL OR REAL PROPERTY, OR FOR INJURY TO ANY PERSON.

This warranty does not apply to products which have been subject to electrical or chemical damage due to improper use, accident, negligence, abuse or misuse. Abuse shall be assumed when indicated by electrical damage to relays, reed switches or other components. The warranty does not apply to products which are damaged during shipment back to FLOWLINE's factory or designated service center or are returned without the original casing on the products. Moreover, this warranty becomes immediately null and void if anyone other than service personnel authorized by Flowline attempts to repair the defective products.

Products which are thought to be defective must be shipped prepaid and insured to FLOWLINE's factory or a designated service center (the identity and address of which will be provided upon request) within 30 days of the discovery of the defect. Such defective products must be accompanied by proof of the date of purchase.

Flowline further reserves the right to unilaterally waive this warranty and to dispose of any product returned to Flowline where:

- a. There is evidence of a potentially hazardous material present with product.
- b. The product has remained unclaimed at Flowline for longer than 30 days after dutifully requesting disposition of the product.

THERE ARE NO WARRANTIES WHICH EXTEND BEYOND THE DESCRIPTION ON THE FACE OF THIS WARRANTY. This warranty and the obligations and liabilities of Flowline under it are exclusive and instead of, and the original purchaser hereby waives, all other remedies, warranties, guarantees or liabilities, express or implied. EXCLUDED FROM THIS WARRANTY IS THE IMPLIED WARRANTY OF FITNESS OF THE PRODUCTS FOR A PARTICULAR PURPOSE OR USE AND THE IMPLIED WARRANTY OF MERCHANTABILITY OF THE PRODUCTS.

This warranty may not be extended, altered or varied except by a written instrument signed by a duly-authorized officer of Flowline, Inc.

# SPECIFICATIONS

## Step One

Tank mounting:	Non-intrusive
Tank mat. comp.:	Non-metallic
Tank wall thick.:	< 1" (25 mm)
Accuracy:	± 1 mm in water
Repeatability:	± 0.5 mm in water
Dielectric range:	> 10 constants
Conductive range:	> 100 micromhos
Supply voltage:	12-36 VDC
Consumption:	25 mA maximum
Contact type:	(1) SPST relay
Contact rating:	120 VAC/VDC @ 1A (CE: 60 VAC/VDC @ 1A)
Contact output:	Selectable NO/NC
Process temp.:	F: -40° to 176° C: -40° to 80°
Enclosure rating:	NEMA 4X (IP65)
Enclosure mat.:	PSO
Conduit entrance:	Single, 1/2" NPT
Bracket material:	1005: PP 5005: PVDF 6005: PE
Bracket mounting:	3M adhesive / plastic thermal weld
Cable jacket mat.:	PP
Cable type:	4-conductor, #22 AWG (shielded)
Cable length:	Standard: 10' (3m) Special order: 25' (7.6m) or 50' (15.2m)
Classification:	General purpose
CE compliance:	EN 61326 EMC EN 61010-1 safety

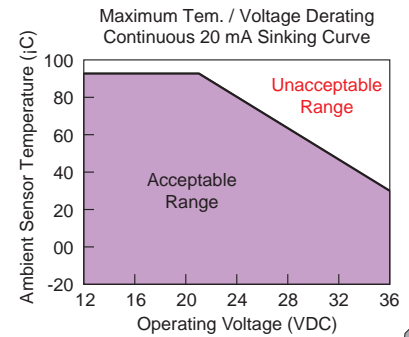
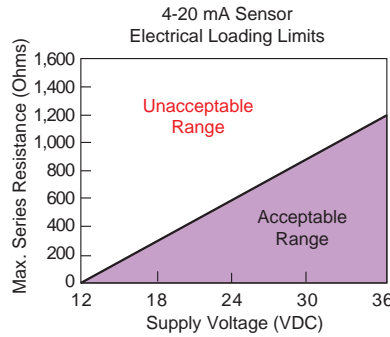

### Technology:

The non-intrusive RF capacitance switch detects the presence of liquid or air by measuring the conductive or dielectric values which are present in all materials. An electrical capacitor is formed between the level switch and the outer tank wall. As liquid rises and falls against the inner wall, the capacitance effect is greatly increased and the 1A SPST relay changes state.

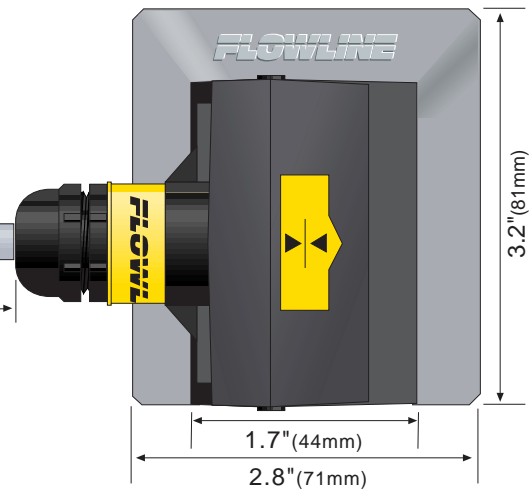
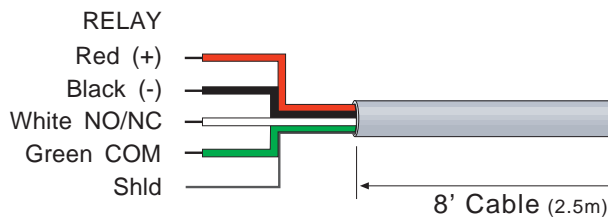
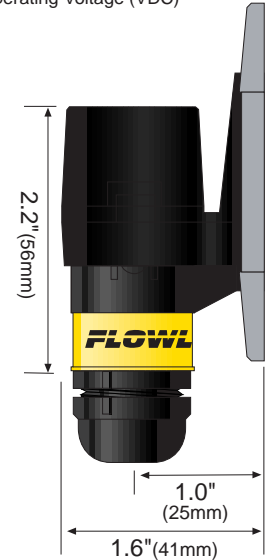

### Table of Common Dielectric Constants:

NOTE: Liquids with a conductivity value > 100 μU are fine if coating is not an issue. Liquids with a dielectric constant less than 20 may not be reliably detected by an LP50 series level switch, depending on conditions.

Acetone	21	Chlorobenzene	4.7 to 6	Ethylene dichloride	11 to 17	Gasoline	2 to 2.2	Nitrobenzene	26 to 35	Trichloroethylene	3.4
Acetaldehyde	22.2	Chlorotoluene	4.7	Ethylene chloride	10.5	Hydrochloric acid	4.6	Nitrotoluene	25	Trichloroacetic acid	4.5
Acetyl methyl hexyl ketone	28	Chloroform	4.5 to 5.0	Ethyl acetate	6.4	Isobutyric acid	2.7	Naphthalene	2.3 to 2.5	Terephthalic acid	1.5 to 1.7
Alcohol	16 to 31	Chlorine, liquid	2.0	Ethyl salicylate	8.6	Isobutyl methyl ketone	13	Oils, vegetable	2.5 to 3.5	Thinner	3.7
Ammonia	15 to 25	Carbon tetrachloride	2.2	Ethyl stearate	2.9	Jet fuel	1.7	Oils, mineral	2.3 to 2.4	Urea	3.5
Acetic acid	4.1 to 6.2	Cyan	2.6	Ethyl silicote	4.1	Lead carbonate	18	Oils, petroleum	1.8 to 2.2	Vinyl chloride	2.8 to 6
Butyl chloride	9.6	Cyclohexanemethanol	3.7	Formic acid	59	Lead nitrate	38	Oleic acid	2.5	Vinyl alcohol	1.8 to 2.0
Barium chloride	9 to 11	D.I. Water	20	Ferric oleate	2.6	Methyl salicylate	9.0	Propane, liquid	1.8 to 1.9	Water, 20°C	80
Benzene	2.3	Ethyl toluene	2.2	Freon	2.2	Methanol	33	Potassium nitrate	5.0 to 5.9	Water, 100°C	48
Benzine	2.3	Ethyl alcohol	23	Glycerine	47	Methyl alcohol	33 to 38	Potassium chloride	5.0		
Barium nitrate	5.6	Ethylene glycol	37	Glycol	30	Margarine, liquid	2.8 to 3.2	Stearic acid	2.3		
Bromine	3.1	Ethylene oxide	14	Glycol nitrite	27	Methyl acetate	7.3	Toluene	2.4		
						N-butyl formate	2.4				

## SAFETY PRECAUTIONS

### Step Two

#### **About this Manual:**

PLEASE READ THE ENTIRE MANUAL PRIOR TO INSTALLING OR USING THIS PRODUCT. This manual includes information on all models of the Switch-Tek Non-Intrusive RF Capacitance level switch from Flowline, LP50-\_005. Please refer to the part number located on the switch label to verify the exact model which you have purchased.

#### **User's Responsibility for Safety:**

Flowline manufactures a wide range of liquid level sensors and technologies. While each of these sensors is designed to operate in a wide variety of applications, it is the user's responsibility to select a sensor model that is appropriate for the application, install it properly, perform tests of the installed system, and maintain all components. The failure to do so could result in property damage or serious injury.

#### **Proper Installation and Handling:**

Because this is an electrically operated device, only properly-trained staff should install and/or repair this product. *The adhesive on the fitting is for temporary installation only.* For permanent installation, the fitting for the sensor should be welded, glassed or strapped to the tank itself using approved plastic welding techniques. Do not install the LP50 series sensor on a metal tank, or within 6" of any metal pipe or fitting.

#### **Mounting Bracket:**

The LP50 series sensor may be mounted in four different fittings. A PE bracket (polyethylene, colored white), model LP95-6001. Other brackets available are LP95-1001 (PP, polypropylene) or LP95-5001 (PVDF, polyvinylidene fluoride). Make sure that the fitting which you have selected is compatible with the tank it will be applied to.

#### **Material Compatibility:**

The sensor itself is not designed to be immersed. It should be mounted in such a way that it does not normally come into contact with fluid. Its case is made out of Polysulfone (PSO). Refer to an industry reference such as the Compass Corrosion Guide (available from Compass Publications, phone 858-589-9636) to ensure that compounds that may splash onto the controller housing will not damage it. Such damage is not covered by the warranty.

#### **Wiring and Electrical:**

The supply voltage used to power the LP50 series sensor should never exceed a maximum of 36 volts DC. Electrical wiring of the sensor should be performed in accordance with all applicable national, state, and local codes.

#### **Flammable, Explosive and Hazardous Applications:**

The LP50-\_005 series switch is not rated for use in hazardous locations. Refer to the National Electric Code (NEC) for all applicable installation requirements in hazardous locations. **DO NOT USE THE LP50-\_005 GENERAL PURPOSE SWITCH IN HAZARDOUS LOCATIONS.**

#### **WARNING**

Do not install the LP50 level switch on a metallic tank, or within 6" of any metallic object. Metal will adversely affect the dielectric sensitivity of the sensor.

FLOWLINE's LP50 series sensors are not recommended for use with electrically charged application liquids. For most reliable operation, the liquid being measured may need to be electrically grounded.

## INTRODUCTION

### Step Three

#### **About Non-Intrusive RF Capacitance Technology:**

FLOWLINE's LP50 series level switch generates a high radio frequency signal from the capacitance electrode on the tank side of each sensor. Depending on the thickness of the tank wall and the material of which it is made, there is a particular minimum dielectric value the electrode measures when there is no liquid on the other side of the tank wall from the sensor. When liquid is on the other side of the wall, the dielectric value rises.

As part of installation, a two-step calibration procedure ensures that the threshold between wet and dry is set at the ideal point for your particular tank and application fluid, without the use of any external test equipment. The sensor's operation and point of actuation may vary based on the dielectric properties of various application liquids, tank materials and thicknesses. The LP50 series sensor is intended to be used with liquids with a dielectric value between 20 and 80. Due to its user calibration capability it may be able to detect liquids below a dielectric constant of 20 under certain conditions, but this must be verified by experimentation.

# INSTALLATION

## Step Four

FLOWLINE's LP50 series level switch may be installed anywhere on a tank wall using the supplied PE, PP, or PVDF fitting that the switch slides into. The fitting comes with adhesive on the tank side that is sufficient to hold the sensor in position temporarily while the installation is tested, but for permanent installation the fitting must be welded, glassed or strapped to the tank. Extra fittings are available from Flowline, so that the level switch may be moved to different locations on the tank by sliding it into other fittings.

### Attach the fitting to the tank:

1. Determine whether the tank is PP, PE or PVDF. The slide-in fitting shipped with the sensor is determined by the part number. If necessary, obtain an additional fitting.

Switch Part No.	Bracket Material	Bracket Part No.
LP50-1005	PP	LP95-1001
LP50-5005	PVDF	LP95-5001
LP50-6005	PE	LP95-6001

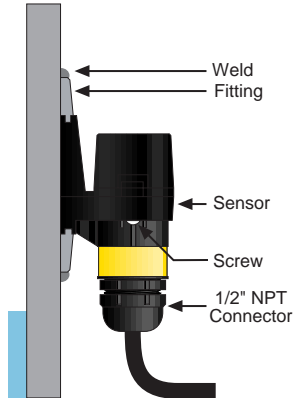

2. Determine the mounting location for the level switch. The point of actuation (where the sensor will send a "wet" signal) is most often at the center of the sensor; however the actual Point of Actuation (POA) may differ depending on the application liquid and tank wall characteristics. After positioning the fitting to check clearances, etc., remove the paper protective strips from the adhesive of the fitting.

3. Press the fitting into place. The adhesive provides a seal between the sensor and the tank wall, and will hold it in place during testing and installation.

If desired, the sensor may be installed temporarily without welding the fitting to the wall. If several different locations must be tried before permanent installation, use double-sided foam stick tape designed for PP, PE or PVDF, for example Arclad type PE-6024, CO#7331 (from Adhesive Research Inc., Glen Rock PA 17327) or equivalent.

4. After the sensor has been tested to verify the POA, weld, glass or strap the fitting to the tank using standard industrial plastic techniques.

### Special note for small round tanks:

The fitting may be attached to small, round tanks, as long as the majority of the fitting is firmly attached to the wall. However, extreme installations may effect the switches performance.

### Mount the sensor in the fitting:

1. Slide the sensor into the fitting.
2. After trimming the sensor wire to length if needed by the installation, thread the sensor wire into a plastic flexible conduit with a 1/2" male fitting. Screw the conduit into the sensor, being careful not to cross the threads. Do not over tighten the conduit in the sensor as this may break the fitting. Such damage is not covered by the warranty. Take care while pulling the wire through conduit that no excessive tension is placed on the sensor end of the wire, so that the wire is not broken from the sensor housing.
3. Connect the sensor wire to the controller following the instructions in its manual. See the following Wiring Section for detailed wiring instructions.

# ELECTRICAL

## Step Five

### Supply Voltage:

The supply voltage to the Switch-Tek level switch should never exceed a maximum of 36 VDC. Flowline controllers have a built-in 13.5 VDC power supply which provides power to all of FLOWLINE's electrically powered sensors. Alternative controllers and power supplies, with a minimum output of 12 VDC up to a maximum output of 36 VDC, may also be used with the Switch-Tek level switch.

### Required Cable Length:

Determine the length of cable required between the Switch-Tek level switch and its point of termination. Allow enough slack to ensure the easy installation, removal and/or maintenance of the sensor. The cable length may be extended up to a maximum of 1000 feet, using a well-insulated, 14 to 20 gauge shielded four conductor cable.

### Wire Stripping:

Using a 10 gauge wire stripper, carefully remove the outer layer of insulation from the last 1-1/4" of the sensor's cable. Unwrap and discard the exposed foil shield from around the signal wires, leaving the drain wire attached if desired. With a 20 gauge wire stripper, remove the last 1/4" of the colored insulation from the signal wires.

### Signal Outputs (Current sensing):

The standard method used by Flowline controllers; this technology uses only two wires (Red and Black). The sensor draws 5 mA when it is dry, and 19 mA when wet. NC/NO status must be set by the controller. The Green and White wires are not used.

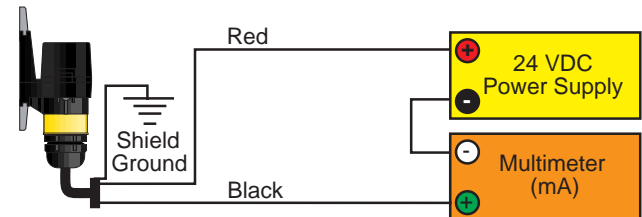

### Signal Outputs (Relay switching):

Allows the sensor to switch a small load on or off directly, using an internal 1 A relay (60 VAC/60 VDC). All models, LP50\_005, use the relay and features 4 wires (red, black, white and green) and a shield wire. The NO/NC status is set by the polarity of the voltage feeding the Red and Black wires. The Green wire is the common for the relay and the White is the NO or NC, depending on the polarity of Red and Black.

### Normally Open Wiring:

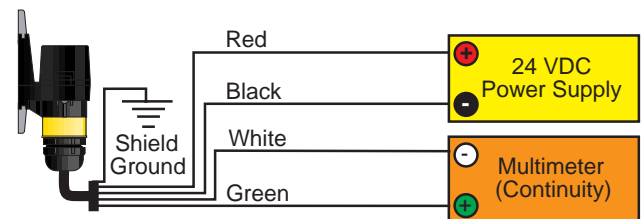

### Normally Closed Wiring:

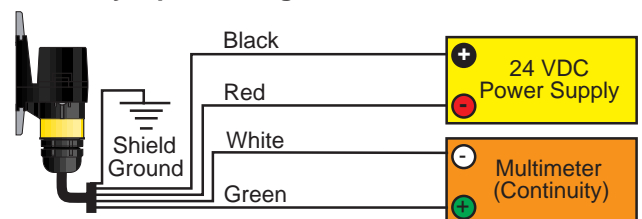

# WIRING

## Step Six

### Wiring to a Flowline Controller LC40 Series Controller:

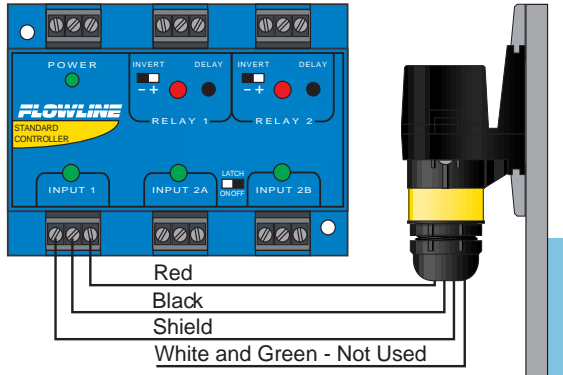

### Wiring as a P-Channel or N-Channel output:

The LP50 Series can be substituted for either a P-Channel (PNP, sourcing) output or a N-Channel (NPN, sinking) output.

### Normally Open DC Load as a P-Channel Output:

To wire as a NO P-Channel output, follow the directions below. The Red wire connects to Positive (+) of the power supply and the Black wire connects to Negative (-). The Green wire is jumpered to the Red wire while the White wire is connected to the LOAD. Jumper the LOAD back to the Negative (-) to complete the circuit.

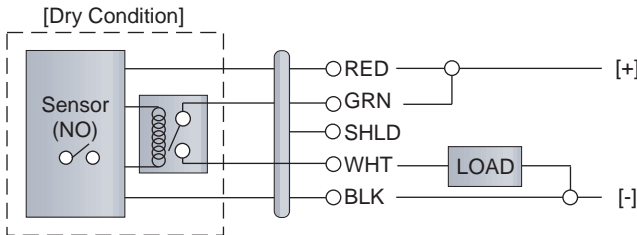

### Normally Closed DC Load as a P-Channel Output:

To wire as a NC P-Channel output, follow the directions below. The Black wire connects to Positive (+) of the power supply and the Red wire connects to Negative (-). The Green wire is jumpered to the Black wire while the White wire is connected to the LOAD. Jumper the LOAD back to the Negative (-) to complete the circuit.

### Normally Open DC Load as a N-Channel Output:

To wire as a NO N-Channel output, follow the directions below. The Red wire connects to Positive (+) of the power supply and the Black wire connects to Negative (-). The White wire is jumpered to the Black wire while the Green wire is connected to the LOAD. Jumper the LOAD back to the Positive (+) to complete the circuit.

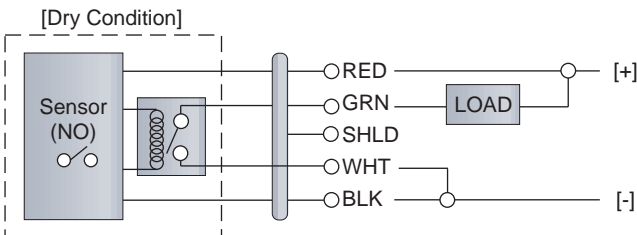

### Normally Closed DC Load as a N-Channel Output:

To wire as a NC N-Channel output, follow the directions below. The Black wire connects to Positive (+) of the power supply and the Red wire connects to Negative (-). The White wire is jumpered to the Red wire while the White wire is connected to the LOAD. Jumper the LOAD back to the Positive (+) to complete the circuit.

# WIRING

## Step Seven

### Wiring the Relay Output:

The Switch-Tek relay output can be wired as a dry contact to a VDC or VAC power source. LP50 Series requires 12 - 36 VDC power to operate the sensor and switch the relay. All illustrations below identify a Dry switch state as the normal position of the relay.

### Switching a Normally Open DC Load:

The Red wire connects to Positive (+) of the power supply and the Black wire connects to Negative (-). The LOAD can be attached to either the Green or White wires. Complete the circuit by either connecting the Green to (+) VDC power or White to (-) VDC power (see illustration below).

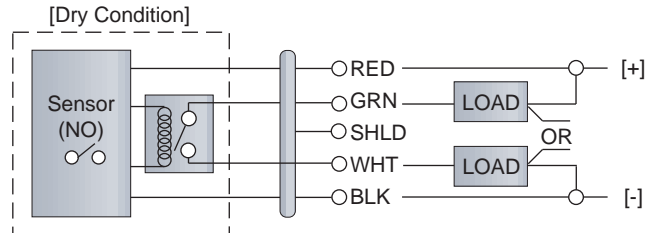

### Switching a Normally Closed DC Load:

The Black wire connects to Positive (+) of the power supply and the Red wire connects to Negative (-). The LOAD can be attached to either the Green or White wires. Complete the circuit by either connecting the Green to (+) VDC power or White to (-) VDC power (see illustration below).

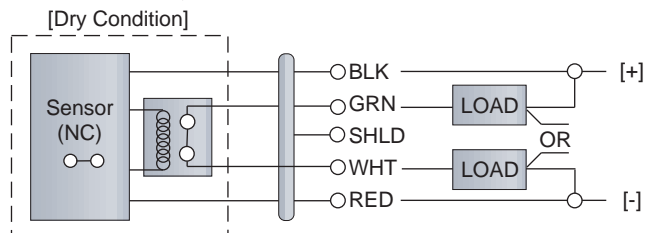

### Switching a Normally Open AC Load:

The Red wire connects to Positive (+) of the DC power supply and the Black wire connects to Negative (-). The LOAD can be attached to the Green wire and the Hot of the VAC power. Connect the White to the Neutral of the VAC power (see illustration below).

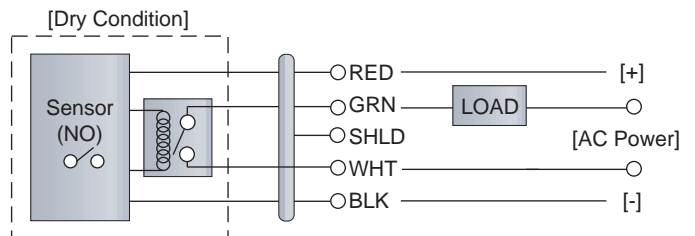

### Switching a Normally Closed AC Load:

The Black wire connects to Positive (+) of the DC power supply and the Red wire connects to Negative (-). The LOAD can be attached to the Green wire and the Hot of the VAC power. Connect the White to the Neutral of the VAC power (see illustration below).

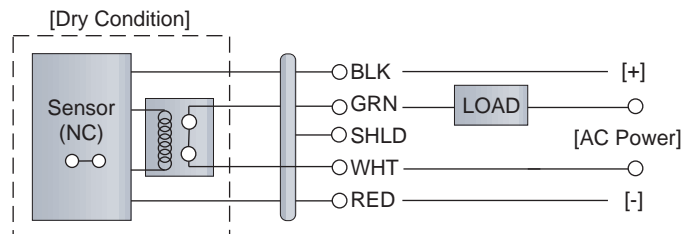

# CALIBRATION

## Step Eight

After it is installed in place, the Switch-Tek must be calibrated by the user before operation. Everything needed for the procedure is self-contained within the electronics of the LP50 series level switch. Two dielectric states—full condition and empty condition—are measured by the Switch-Tek, and then averaged to set the threshold between “wet” and “dry” at the sensor. The empty state must be at least 6" below the bottom of the sensor for calibration. The full state must be to the top of the sensor (not just to the point of actuation) for calibration. The actual application fluid at its intended operating temperature must be used during calibration. Use the following procedure assumes that the sensor has already been wired to a power supply.

1. Remove the cap from the sensor body by loosening the two screws located below the sensor. Do not remove the screws from the sensor. Insert a small screwdriver into the small slot at the edge of the cap and gently pry upwards.
2. Looking down you will see a small three-position switch and two trimpots marked Full and Empty. You may start with whatever state the tank is in.

3. Full state: With the tank filled to the top of the sensor, set the switch to the Full position (right). Make sure your hands or any other objects are not touching the sensor while calibrating because this will cause a false reading. Using a small nonmetallic screwdriver or alignment tool, turn trimpot Full until the LED just lights, and no farther. Note the position. Now turn the trimpot back until the LED turns off. The ideal setting for the trimpot is midway between these on and off points.

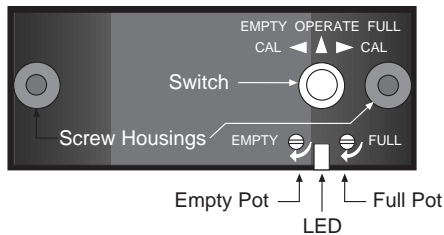

4. Empty state: With the tank drained to a point no closer than 6 inches below the bottom of the sensor, set the switch to the Empty position (left). Set the Empty trimpot as in Step 3.
5. After completing calibration, make sure to return the switch to the center position. Snap the cap back on by pressing down, and tighten the two screws.

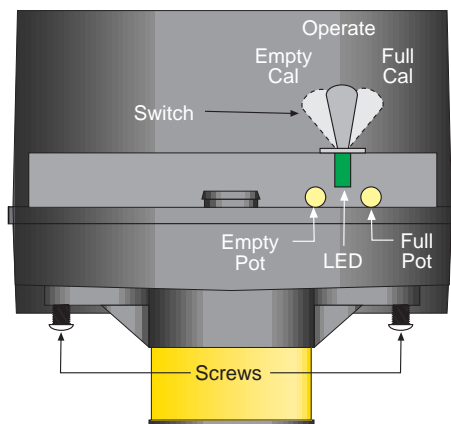

# CALIBRATION

## Step Nine

### Checking the Point of Actuation:

Raise the fluid level to the point where the sensor sends a “wet” signal (Input LED will turn Amber on Flowline controllers). The “dry” signal should be sent when the fluid level is lowered (Input LED will turn Green on Flowline controllers). The actual Point of Actuation (POA) depends on many variables, including the thickness of the wall and the dielectric value of the liquid. For example, thicker tank walls can raise the POA while thinner walls could lower the POA.

If the POA needs to be changed, measure the distance and remount the sensor in a new location.

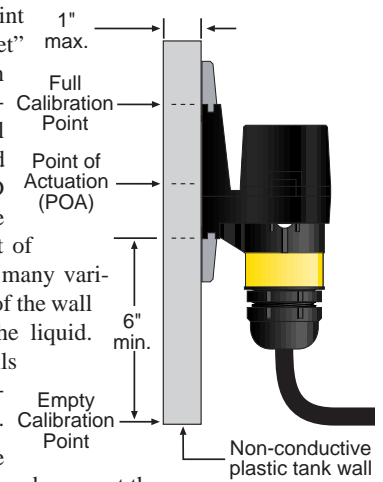

**Do not attempt to change the Point of Actuation by intentional miscalibration.**

If the sensor does not signal wet and dry reliably, it may be that:

- the dielectric constant of the application fluid is too low
- the tank wall is too thick for the application fluid
- there are static or other electrical charges in the fluid
- metal objects are within 6" of the sensor
- calibration was performed incorrectly

Try the calibration procedure again, after making corrections if possible. If the full and empty states are too similar dielectrically, it may not be possible to use a capacitance sensor.

### Testing the Sensor:

1. **Power:** Apply power to sensor, by connecting power to the controller and/or power supply.
2. **Full condition:** Fill the tank with the application liquid, by filling the tank up to the sensor’s point of actuation.
3. **Test:** With the sensor being fluctuated between wet and dry states, use a multimeter to ensure that the correct signals are being produced by the Switch-Tek level switch, or observe the sensor indicator light in the controller.
4. **Point of Actuation:** Observe the point at which the rising or falling fluid level causes the sensor to change state, and move the installation of the sensor if necessary.

### Maintenance:

The LP50 series level switch itself requires no periodic maintenance except cleaning as required. However, periodically clean any coating or scaling on the tank wall the sensor is attached to and check the calibration. It is the responsibility of the user to determine the appropriate maintenance schedule, based on the specific characteristics of the application liquids. In addition, any dripping or condensation between the sensor and the tank wall fitting may need to be periodically cleaned to maintain accuracy.



**SCIGATE AUTOMATION (S) PTE LTD**

No.1 Bukit Batok Street 22 #01-01 Singapore 659592

Tel: (65) 6561 0488

Fax: (65) 6562 0588

Email: [sales@scigate.com.sg](mailto:sales@scigate.com.sg)

Web: [www.scigate.com.sg](http://www.scigate.com.sg)

Business Hours: Monday - Friday 8.30am - 6.15pm