

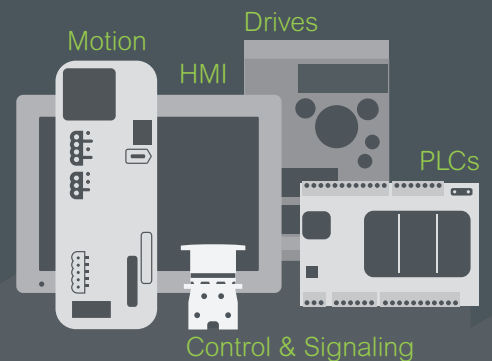

Introducing the **Easy Series**

Essential automation & control products

When just enough is just right!



Easy Harmony iPC

Human Machine Interfaces



SCIGATE AUTOMATION (S) PTE LTD

No.1 Bukit Batok Street 22 #01-01 Singapore 659592

Tel: (65) 6561 0488

Fax: (65) 6562 0588

Email: sales@scigate.com.sg

Web: www.scigate.com.sg

Business Hours: Monday - Friday 8.30am - 6.15pm

www.se.com

Life Is On



General contents

Easy Harmony *i*PC

Selection guide page 2

■ Presentation

□ Benefits page 4

□ EcoStruxure Architecture page 4

□ Overview of the offer page 5

■ Description page 6

■ References page 8

■ Product reference index page 10





Human Machine Interfaces

Easy Harmony iPC

HMIPSO Optimized - 15" and 15.6" touch screens

HMIPSP Performance - 15.6" and 18.5" touch screens

HMIEP5 Box PC

Type of Easy Harmony iPC	HMIPSO Optimized Panel PC	HMIPSP Performance Panel PC	HMIEP5 Box PC
			
			
Fanless	★★★★★		
Mounting type	Panel mounting and VESA mounting		Wall and VESA mounting
Screen	LCD, single-touch resistive screen		
Type	-		
Size	15"	15.6"	18.5"
Resolution	XGA, 1024 × 768 pixels, 16 million colors	FWXGA, 1366 × 768 pixels, 16 million colors	
Degree of protection	IP65 front panel		
View angle	Vertical 160°, horizontal 170°		
Backlight	Life span > 50,000 hours @ 25 °C/77 °F		
CPU	Intel Celeron 3855U (1.6 GHz)		Intel Core i5-6200U (2.3 GHz)
Expansion slots	1x 2.5" SATA slot and 1x M.2 slot (M.2 support mSATA SSD only)		1x 2.5" SATA slot and 1x M.2 slot (M.2 supports mSATA SSD and NVMe SSD)
Storage	mSATA SSD 128 GB (BiCS3 3D NAND flash disk)		1x 2.5" SATA slot and 1 x M.2 slot
Main drive	1x mini PCIe slot (mSATA)		
Slots	4 GB (non-expandable)		8 GB (non-expandable)
RAM	4 GB (non-expandable)		8 GB (non-expandable)
Integrated ports	<ul style="list-style-type: none"> 2x COMs (RS232/RS422/RS485, switchable by DIP switch) 4x USB 3.0 2x RJ45 10/100/1000 Mbps 		
Watchdog timer	Programmable 255-level timer interval		
Operating system	Windows 10 IoT Enterprise (64-bit multilingual)		- (no pre-installed OS)
Power supply	12...24 V ⎓ (-15%/+20%), 2-pin power terminal		
Supply voltage	≤ 60 W		
Power consumption			
Dimensions	Overall (W × H × D)		
Overall (W × H × D)	393 x 293 x 47 mm (15.5 × 11.5 × 1.85 in.)	400 x 254 x 50.5 mm (15.8 × 10.0 × 1.98 in.)	400 x 254 x 50.5 mm (15.8 × 10.0 × 1.98 in.)
Mounting cut-out (W × H)	383 x 283 mm (15.1 x 11.1 in.)	390 x 244 mm (15.4 x 9.6 in.)	390 x 244 mm (15.4 x 9.6 in.)
Mounting cut-out (W × H)			457 x 283 mm (18.0 x 11.1 in.)
Mounting cut-out (W × H)			227.5 x 170 x 58.4 mm (8.96 × 6.69 × 2.3 in.)
Mounting cut-out (W × H)			156 x 156 mm (6.14 x 6.14 in.), 4 x M4 screws
Temperature	During operation (1)		
During operation (1)	0...55 °C/32...131 °F (with SSD), 0...45 °C/32...133 °F (with HDD)		
During storage	-20...60 °C/-4...140 °F		
Vibration resistance	During operation		
During operation	1 g from 3...150 Hz		
HMI software	EcoStructure™ Machine SCADA Expert		Yes (not pre-installed)
Standards and certification	CE		
References	HMIPSOS742D1W01	HMIPSOS752D1W01	HMIPSPS752D1X01
Page	8	8	8
			HMIPSPS952D1X01
			8
			HMIEP5CBN54N0F1
			8
			HMIEP55BN58N0F1
			8

(1) EcoStructure™ Machine SCADA Expert is pre-installed in Easy Harmony Panel PC as a trial version, activated with subscription.

Human Machine Interfaces

Easy Harmony iPC

HMIPSO Optimized - 15" and 15.6" touch screens

HMIPSP Performance - 15.6" and 18.5" touch screens

HMIEP5 Box PC



Presentation

Easy Harmony iPC are the entry level industrial PCs. These simple-in-design iPCs with Intel Celeron 3855U and Intel Core i5-6200U CPU cater for the performance requirements of most automation applications in the field.

Benefits

- Fit for purpose
 - Panel PC LCD backlight: 50,000 hours life time @ 25 °C/77 °F
 - Simple and compact all-in-one hardware
 - Panel PC pre-installed with EcoStruxure[™] Machine SCADA Expert
 - Panel PC supports COM option card with 2 additional COM ports
 - Box PC supports Ethernet option card with 4 additional Ethernet ports
- Robustness adapted to the environment
 - On-board DDR memory and SSD for protection against the vibration
 - Single-touch resistive screens suitable for industrial application
 - Panel PC have IP65 front protection
- Easy to use
 - Fanless cooling for maintenance free operation
 - M.2 (mSATA) slot and 2.5 inch SATA slot, easy for extension

EcoStruxure Architecture

EcoStruxure[™] is Schneider Electric's innovative IoT architecture addressing the needs of automation applications for a wide range of industries. The new Easy Harmony iPC meets IIoT challenges at the Edge Control level by enabling secured communication from connected products on the shop floor to the required software and applications on the top floor. This provides improved profitability and new business opportunities, through enhanced asset performance for more efficient operation and maintenance of capital assets. Easy Harmony iPC offers smart application design and engineering to leverage asset performance with end-to-end cybersecurity.

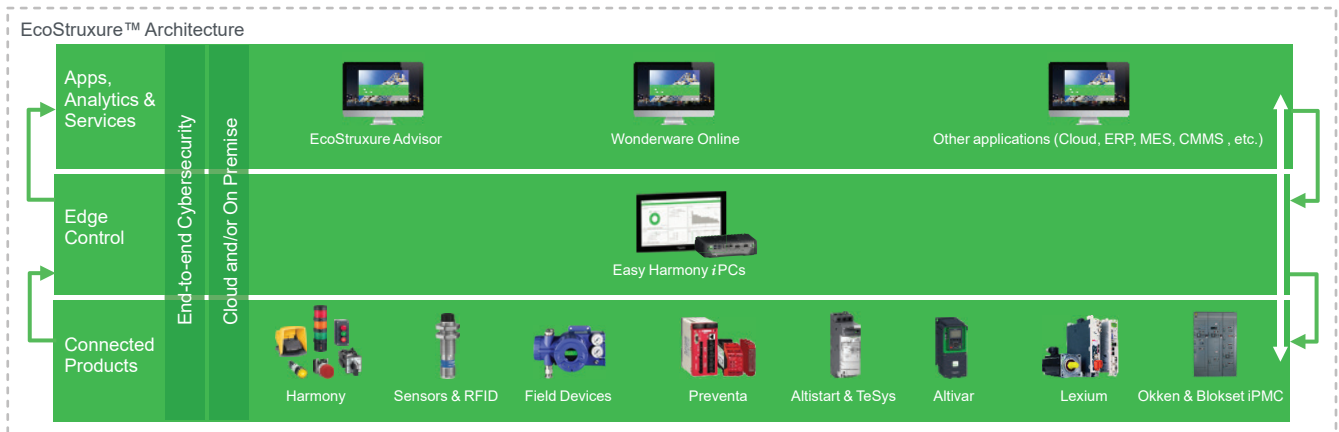

Human Machine Interfaces

Easy Harmony iPC

HMIPSO Optimized - 15" and 15.6" touch screens

HMIPSP Performance - 15.6" and 18.5" touch screens

HMIEP5 Box PC



Easy Harmony HMIPSO Optimized 15" and 15.6" Panel PC



Easy Harmony HMIPSP Performance 15.6" and 18.5" Panel PC



Easy Harmony HMIEP5 Box PC



EcoStruxure Machine Expert



EcoStruxure Machine SCADA Expert

Presentation (continued)

Overview of the offer

Easy Harmony HMIPSO Optimized Panel PC

The Easy Harmony HMIPSO Optimized Panel PC offer comprises 2 references, each equipped with:

- Fanless Intel Celeron 3855U (1.6 GHz)
- 4 GB DDR4 RAM, default mounted (non-expandable)
- Connection ports: 4x USB 3.0, 2x COM (RS-232/422/485), 2 Gigabit Ethernet
- Power supply: 12...24 V \pm (-15%/+20%)
- Operating system: Windows 10 IoT Enterprise (64-bit multilingual)

Easy Harmony HMIPSP Performance Panel PC

The Easy Harmony HMIPSP Performance Panel PC offer comprises 2 references, each equipped with:

- Fanless Intel Core i5-6200U (2.3 GHz)
- 8 GB DDR4 RAM, default mounted (non-expandable)
- Connection ports: 4x USB 3.0, 2x COM (RS-232/422/485), 2 Gigabit Ethernet
- Power supply: 12...24 V \pm (-15%/+20%)
- Operating system: Windows 10 IoT Enterprise (64-bit multilingual)

Easy Harmony HMIEP5 Box PC

Easy Harmony HMIEP5 Box PC offer comprises 2 references, each equipped with:

- Fanless Intel Celeron 3855U (1.6 GHz) or Core i5-6200U (2.3 GHz)
- 4 GB or 8 GB DDR4 RAM, default mounted (non-expandable)
- Connection ports: 4x USB 3.0, 2x COM (RS-232/422/485), 2 Gigabit Ethernet
- Power supply: 12...24 V \pm (-15%/+20%)
- No pre-installed operating system

Ready-to-run software for Easy Harmony iPC

Easy Harmony iPCs are supported by Schneider Electric HMI software. For HMI applications, EcoStruxure Machine SCADA Expert trial version is pre-installed on Easy Harmony HMIPSO/HMIPSP Panel PC and activated to unlimited version with subscription.

For more information on EcoStruxure Machine Expert and EcoStruxure Machine SCADA Expert, please visit our website www.schneider-electric.com.

Description

Human Machine Interfaces

Easy Harmony iPC

HMIPSO Optimized - 15" and 15.6" touch screens

HMIPSP Performance - 15.6" and 18.5" touch screens

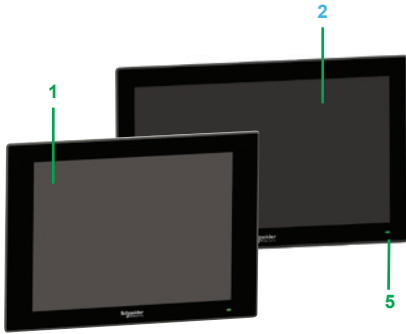

Easy Harmony HMIPSO Optimized 15" and 15.6" Panel PC Front view

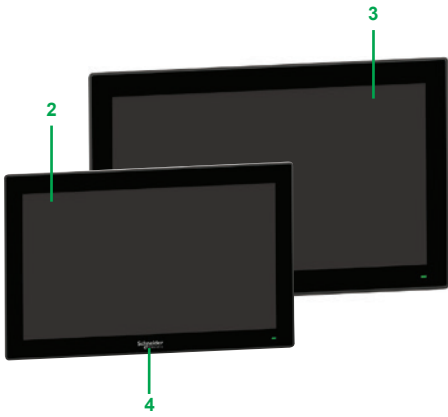

Easy Harmony HMIPSP Optimized 15.6" and 18.5" Panel PC Front view

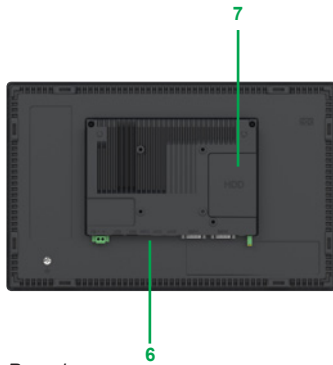

Rear view

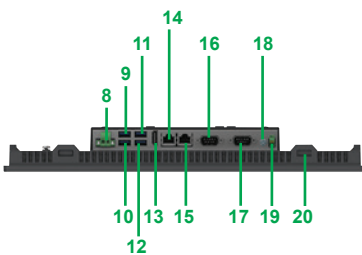

Underside view

Description

Easy Harmony HMIPSO Optimized: 15" and 15.6" touch screens,

Easy Harmony HMIPSP Performance: 15.6" and 18.5" touch screens

Front view

- 1** 15" LCD with LED backlight, XGA 1024 x 768 pixels, and 16 million colors for **HMIPSOS742D1W01**:
 - Brightness: 350 cd/m² (adjustable)
 - Type of touch panel: single-touch resistive screen
 - Typical viewing angle: 160° (vertically)/170° (horizontally)
- 2** 15.6" LCD with LED backlight, FWXGA 1366 x 768 pixels, and 16 million colors for **HMIPSOS752D1W01** and **HMIPSPS752D1X01**:
 - Brightness: 400 cd/m² (adjustable)
 - Type of touch panel: single-touch resistive screen
 - Typical viewing angle: 160° (vertically)/170° (horizontally)
- 3** 18.5" LCD with LED backlight, FWXGA 1366 x 768 pixels, and 16 million colors for **HMIPSPS952D1X01**:
 - Brightness: 450 cd/m² (adjustable)
 - Type of touch panel: single-touch resistive screen
 - Typical viewing angle: 160° (vertically)/170° (horizontally)
- 4** Schneider Electric sticker
- 5** Power status indicator (Green: On, Red: Stand-by, No light: Off)

Rear view

- 6** Panel PC interface
- 7** Cover for mini PCIe card and HDD/SSD drive

Underside view

- 8** DC power connector
- 9** 1x USB1 (USB 3.0)
- 10** 1x USB2 (USB 3.0)
- 11** 1x USB3 (USB 3.0)
- 12** 1x USB4 (USB 3.0)
- 13** 1x HDMI
- 14** 1x Ethernet LAN1 (10/100/1,000 Mbps)
- 15** 1x Ethernet LAN2 (10/100/1,000 Mbps)
- 16** 1x COM1 RS-232/422/485 port
- 17** 1x COM2 RS-232/422/485 port
- 18** Power ON/OFF button
- 19** Remote Switch
- 20** Snap hook

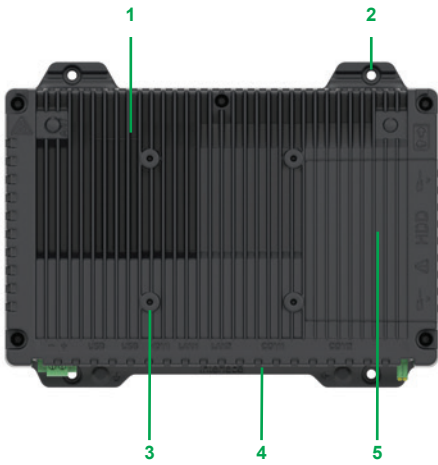

Easy Harmony HMIEP5 Box PC
Front view

Description

Easy Harmony HMIEP5 Box PC

Front view

For both **HMIEP5CBN54N0F1** and **HMIEP55BN58N0F1**

- 1 Aluminum housing
- 2 Wall mounting design
 - External dimension: 227.5 x 170 x 58.4 mm
 - Installation dimension: 156 x 156 mm, by 4 x M4 screws
- 3 VESA mounting design
 - Installation Dimension: 75 x 75 mm, by 4 x M4 screws
- 4 Box PC interfaces
- 5 Cover for mini PCIe card and HDD/SSD drive installation

Rear view

- 6 Supports 3rd party DIN rail adapter (UTA 136 - 2853996)
- 7 Harmony (range name) Logo

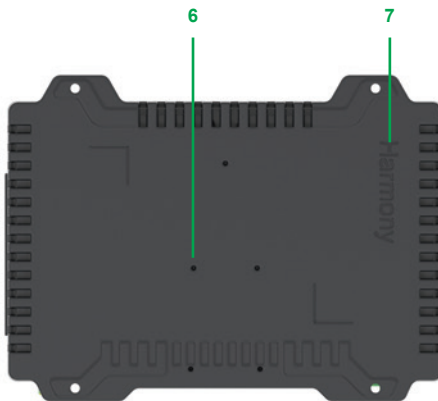

Rear view

Underside view

- 8 DC power connector
- 9 1x USB1 (USB 3.0)
- 10 1x USB2 (USB 3.0)
- 11 1x USB3 (USB 3.0)
- 12 1x USB4 (USB 3.0)
- 13 1x HDMI
- 14 1x Ethernet LAN1 (10/100/1,000 Mbps)
- 15 1x Ethernet LAN2 (10/100/1,000 Mbps)
- 16 4x Ethernet (optional expand card, 10/100/1,000 Mbps)
- 17 1x COM1 RS-232/422/485 port
- 18 1x COM2 RS-232/422/485 port
- 19 Power ON/OFF button
- 20 Remote Switch

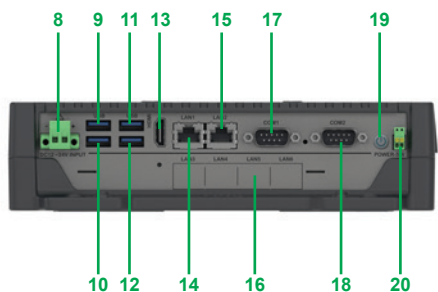

Underside view

Human Machine Interfaces

Easy Harmony iPC

HMIPSO Optimized - 15" and 15.6" touch screens

HMIPSP Performance - 15.6" and 18.5" touch screens

HMIEP5 Box PC

IPC_CP137



HMIPSOS742D1W01

Easy Harmony HMIPSO Optimized Panel PC

Supply voltage	Operating system	Software	CPU	Screen size	Reference	Weight kg/lb
12...24 V $\overline{\text{---}}$ (-15%/+20%), 2-pin power terminal	Windows 10 IoT Enterprise (64-bit multilingual)	EcoStruxure Machine SCADA Expert	Intel Celeron 3855U (1.6GHz)	15"	HMIPSOS742D1W01	3.850/ 8.490
				15.6"	HMIPSOS752D1W01	3.800/ 8.380

IPC_CP141



HMIPSOS742D1W01

Easy Harmony HMIPSP Performance Panel PC

Supply voltage	Operating system	Software	CPU	Screen size	Reference	Weight kg/lb
12...24 V $\overline{\text{---}}$ (-15%/+20%), 2-pin power terminal	Windows 10 IoT Enterprise (64-bit multilingual)	EcoStruxure Machine SCADA Expert	Intel Core i5-6200U (2.3GHz)	15.6"	HMIPSPS752D1X01	3.800/ 8.380
				18.5"	HMIPSPS952D1X01	4.750/ 10.470



HMIEP5●BN5●N0F1

Easy Harmony HMIEP5 Box PC

Supply voltage	Operating system	Software	CPU	Screen size	Reference	Weight kg/lb
12...24 V $\overline{\text{---}}$ (-15%/+20%), 2-pin power terminal	No pre-installed operating system	N/A	Intel Celeron 3855U (1.6 GHz)	N/A	HMIEP5CBN54N0F1	1.60/ 3.53
			Intel Core i5-6200U (2.3GHz)	N/A	HMIEP5BN58N0F1	1.60/ 3.53

Human Machine Interfaces

Easy Harmony iPC

HMIPSO Optimized - 15" and 15.6" touch screens

HMIPSP Performance - 15.6" and 18.5" touch screens

HMIEP5 Box PC

Separate components

Description	Details	Compatible with Easy Harmony iPC		Reference	Weight kg/lb
		HMIPSO/HMIPSP Panel PC	HMIEP5 Box PC		
Accessory kit	<ul style="list-style-type: none"> ■ Snap hook and screw ■ 2-pin power terminal ■ 2.5" HDD/SSD mounting bracket 	All models	N/A	HMIYPACCKTPSX1	0.200/ 0.440

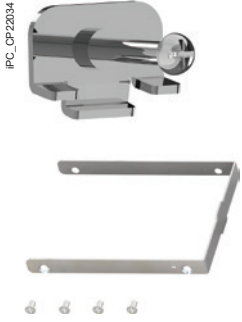

HMIYPACCKTPSX1

COM option card	2 x COM (RS232, RS422/RS485) via GPIO interface	All models	N/A	HMIYEPOM1	0.05/ 0.11
-----------------	---	------------	-----	---------------------------	---------------



HMIYEPOM1

ETH option card	4 x Ethernet ports via M.2 interface	N/A	All models	HMIYEPETH1	0.05/ 0.11
-----------------	--------------------------------------	-----	------------	----------------------------	---------------



HMIYEPETH1

H	
HMIEP5CBN54N0F1	8
HMIEP55BN58N0F1	8
HMIPSOS742D1W01	8
HMIPSOS752D1W01	8
HMIPSPS752D1X01	8
HMIPSPS952D1X01	8
HMIYPCOM1	9
HMIYEPETH1	9
HMIYPACCKTPSX1	9

Life Is On



Learn more about our products at
www.se.com

The information provided in this documentation contains general descriptions and/or technical characteristics of the performance of the products contained herein. This documentation is not intended as a substitute for and is not to be used for determining suitability or reliability of these products for specific user applications. It is the duty of any such user or integrator to perform the appropriate and complete risk analysis, evaluation and testing of the products with respect to the relevant specific application or use thereof. Neither Schneider Electric nor any of its affiliates or subsidiaries shall be responsible or liable for misuse of the information contained herein.

Design: Schneider Electric
Photos: Schneider Electric

Schneider Electric Industries SAS

Head Office
35, rue Joseph Monier - CS 30323
F-92500 Rueil-Malmaison Cedex
France

DIA5ED2190601EN
September 2022 - V4.0